

SY75C

**SANY**

Quality Changes the World



# COMPACT POWERHOUSE

VERSATILE AS STANDARD.

CONSTRUCTION MACHINERY



**COMPACT EXCAVATORS**  
**SY75C**

Engine  
YANMAR 4TNV98CT  
Rated Power  
42.4 kW / 1 900 rpm  
Bucket capacity  
0.28 m<sup>3</sup>  
Operating mass  
7 280 kg

# SANY

**For challenging tasks,  
you need a first-class partner**

Quality comes from experience. And from new ideas. This is why we combine these two crucial factors at SANY. This is because we are one of the world's leading producers, having sold more than **320 000** excavators in **10 years**. This means that you can always rely on sophisticated products that have been tried and tested in practice. An impressive **5–7%** of our annual turnover is dedicated to research and development. This is why we give you not only our word, but also our extraordinary **five-year warranty** as a guarantee of how powerful and robust our products are.

**320 000**  
EXCAVATORS SOLD IN  
**10 YEARS**

**5–7%**  
TURNOVER FOR RESEARCH  
AND DEVELOPMENT

**FIVE-YEAR  
WARRANTY\***

Quality Changes the World

\* Applicable in certain markets, please check with your local dealer.



**SY75C**

## RAISING THE BAR IN THE COMPACT CLASS

The new SANY SY75C – powerful and with a large excavation depth, this machine completes all tasks efficiently and with a reliable performance. The excavator's sophisticated structure allows it to tackle very high loads with exemplary stability. Moreover, the cab's state-of-the-art design is reminiscent of a comfortable car interior. This is not only visually appealing to drivers – the cab's comfort and ergonomics are precisely tailored to the requirements for safe and concentrated work.

### SY75C HARD FACTS

Max. bucket digging force  
53 kN (ISO)

Max. arm digging force  
35 kN (ISO)

Swingspeed  
10.5 rpm

Max. travel speed  
5.3 km/h

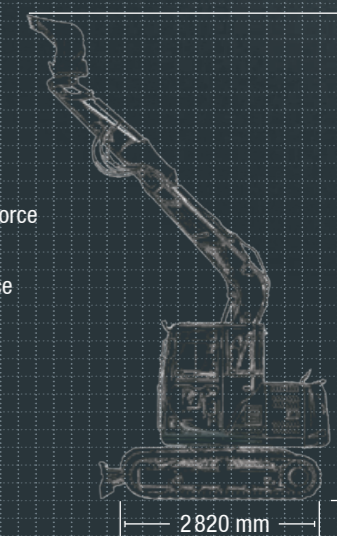

COMPONENTS

# QUALITY TO THE LAST DETAIL

In conjunction with the exhaust treatment, the Yanmar engine always delivers a full and clean performance for every task. Its diesel particulate filter with self-regenerating coating ensures that the emission control is straightforward and performs reliably. Another benefit when it comes to durability and reliability is the fact that the top rollers are mounted on both sides. This makes them more robust, even when subjected to high stress.

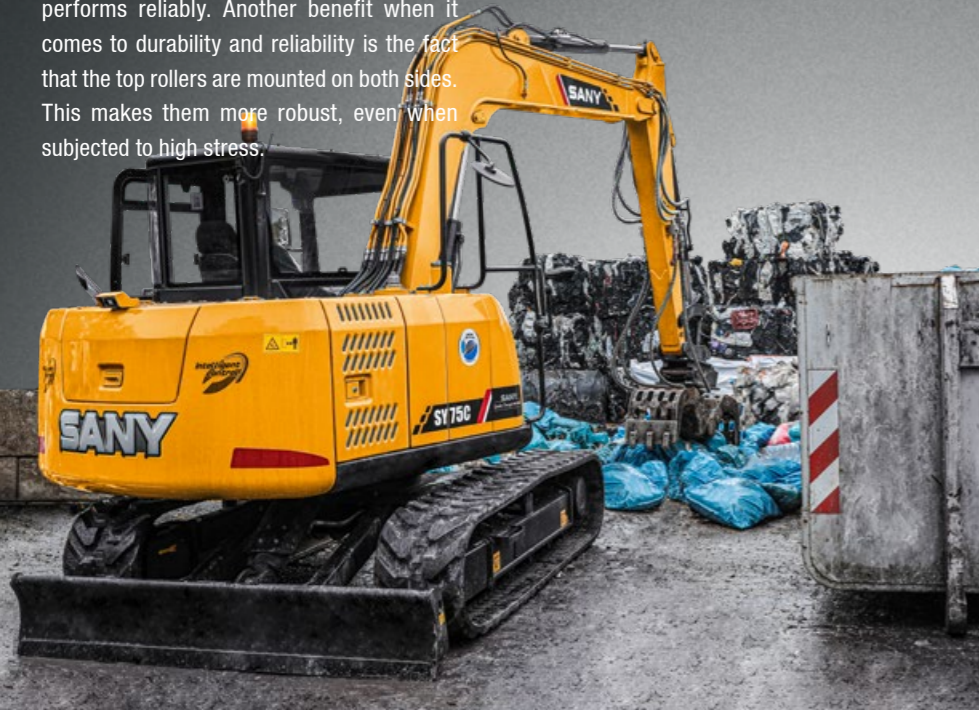

## QUALITY

**Completely sealed** – the driver's cab's improved seal makes it a real comfort zone, keeping out noise, dust, exhaust gases, etc.

## USER EXPERIENCE

**Always optimally configured** – it is easy to program different attachment devices, which saves time and money when changing them. The machine's modern interior ensures maximum comfort and therefore facilitates fatigue-free work. In addition, the Bluetooth interface allows operators to connect their mobile phone to the factory-fitted speakers to answer calls or play music.

## SAFETY

**Everything in sight** – the protected rear camera gives an accurate image of the surrounding area. The driver can see these images on the high-resolution display directly in their field of vision.



## DIMENSIONS

**Optimal design** – the undercarriage and structure are perfectly coordinated. The position of the boom also means that the excavator can lift higher loads over longer reaches than comparable machines in this weight class.

## COMPONENTS

**Powerful and clean** – the high-torque Yanmar engine delivers full power in every situation. In addition, with its tailored exhaust treatment, the machine achieves emission standard 5 without any difficulty.

## ECONOMY

**Designed for maximum efficiency** – the intelligent load-sensing hydraulic system always knows precisely how much hydraulic power is required for each task and delivers precisely the amount of oil needed.

## Absolute reliability – for peace of mind!

SANY's five-year warranty\* gives you the assurance that you can fully count on your equipment.



\* With participating partners



COMPONENTS

## Both hard and soft

The SY75C does not have any plastic covers. This machine consists solely of high-quality steel, which is particularly robust and quick and easy to repair in case of an emergency.

Despite weighing almost 7.5 tonnes, the compact extractor is gentle on the ground with its rubber crawler tracks. This protects a wide range of surfaces from damage and makes the machine drive smoothly.



USER EXPERIENCE

# ON-BOARD COMFORT

While comfort has a lot to do with convenience, it has even more to do with health and safety and facilitating fatigue-free, concentrated work. Machine operators are therefore the focus of the entire design for the driver's cab. At the forefront are the joysticks, which make particularly precise work easy, and the high-resolution 7" touch display, which impresses with its simple and intuitive menu navigation and can even be operated when wearing gloves.

Moreover, the Bluetooth interface allows users to connect their phone in order to answer calls or simply to play music.

USER EXPERIENCE

## Quicker maintenance

It is important to carry out routine daily checks. In spite of the machine's large dimensions, all of the areas relevant for maintenance – such as the air filter and engine oil monitoring – are arranged so that they are quickly and easily accessible from the ground.

USER EXPERIENCE

## Optimal visibility in every respect

The extra-large front and side windows, as well the curved rear window provide optimal visibility of the entire working environment without any areas hidden. The standard rear camera covers visibility to the rear, sending a high-resolution image to the 7" touch display. There are also easy-to-adjust sun covers, which enable glare-free work even in difficult lighting conditions.



ECONOMY

## Cost-effectiveness as standard

The high-torque drive unit is particularly fuelefficient, without sacrificing any performance. The driver can simply choose the optimal operating mode for different applications. For instance, you can switch from maximum power to maximum efficiency via touch operation and this will be reflected in the fuel costs. Another feature which saves time and costs is the fact that hydraulic quick-coupler is already included ex-works as standard and is incorporated into the overall operating concept. This makes it quick and easy to change attachment devices at the construction site and neatly incorporates this function into the overall operation of the machine.

ECONOMY

## Exert a lot of pressure

Tried-and-tested Kawasaki technology is used for the machine's hydraulics. It can deliver up to 158 litres per minute, which is sufficient even for major tasks. Depending on the application, the load-sensing hydraulic system ensures that the machine always delivers precisely the amount of hydraulic power requested by the operator.



### Our highlights – the added benefits SANY offers you:

- + Comfortable driver's cab with modern equipment
- + Extensive programming options for attachment devices
- + Rear camera
- + High-resolution 7" touch display
- + 2 proportional auxiliary control circuits on the joystick

SAFETY

## You can rely on

SANY makes no compromises when it comes to safety. Four LED work spotlights provide the best possible illumination of the work environment, even if it starts to get dark at the construction site.

Another safety feature is the accumulator, which allows the working device to be lowered in an emergency without the engine running.

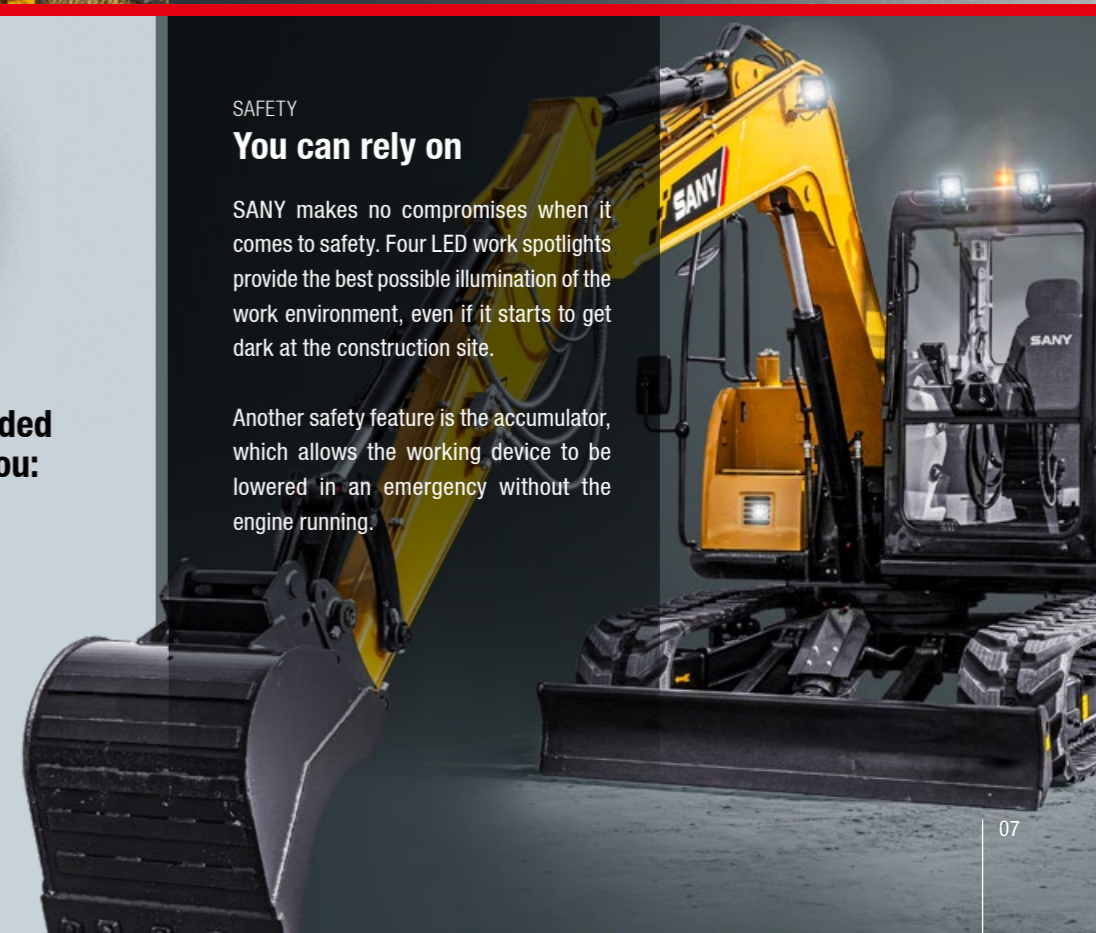

## ENGINE

Model	YANMAR 4TNV98CT
Typ	Water-cooled, 4 cylinder, with commonrail and DPF
Exhaust emissions	Stage V
Rated power	42.4 kW / 1 900 rpm
Max. torque	241 Nm / 1 300 rpm
Displacement	3 319 ccm
Batteries	1 × 12 V / 120 Ah

## HYDRAULIC SYSTEM

Mainpump	Variable-piston-pump; Load sensing control
Max. oilflow	158 l/min
Travelmotor	Variable displacement axial piston motor
Swingmotor	Axial piston motor
Max. oilflow (AUX 1)	120 l/min
Max. oilflow (AUX 2)	70 l/min

## SERVICE REFILL CAPACITIES

Fuel tank	150 l
Engine coolant	11 l
Engine oil	10.8 l
Drive (per side)	1.2 l
Hydraulic system	160 l
Hydraulic oil tank	120 l

## PERFORMANCE

Swingspeed	10.5 rpm
Max. travel speed	High 5.3 km/h, slow 2.8 km/h
Max. travel force	56.8 kN
Gradeability	35°
Bucket capacity	0.28 m <sup>3</sup>
Groundpressure	0.33 kg/cm <sup>2</sup>
Bucket digging force ISO	53 kN
Arm digging force ISO	35 kN

## RELIEF VALVE SETTINGS

Implement circuit	263 bar
Swing circuit	240 bar
Travel circuit	263 bar
Pilot pressure	39 bar

## UNDER AND UPPER STRUCTURE

Boom length	3 720 mm
Arm length	2 050 mm
Bottomrollers	5
Toprollers	1
Rotation device	Planetary gear reducer driven by an axial piston motor, automatic hydraulic released slewing brake

## OPERATING MASS

SY75C 7 280 kg

## LIFTING CAPACITIES - DOZER BLADE DOWN

Load point height	Radius			Digging reach	
	1.0 m	3.0 m	5.0 m	Max.	
6.0 m kg	1 385 1 385			1 210	1 210
5.0 m kg				1 020	1 020
4.0 m kg	1 315 1 315 1 060 1 060			950	950
3.0 m kg	1 710 1 710 1 460 1 225			930	930
2.0 m kg	2 275 2 275 1 585 1 190			950	950
1.0 m kg	2 790 2 400 1 715 1 155			960	950
Ground line kg	3 085 2 315 1 815 1 125			1 105	980
-1.0 m kg	2 105	2 105	3 138 2 275 1 805 1 115	1 300	1 070
-2.0 m kg	3 415	3 415	2 955 2 280	1 680	1 275
-3.0 m kg	2 395 2 340			1 885	1 820

## LIFTING CAPACITIES - DOZER BLADE UP

Load point height	Radius			Digging reach	
	1.0 m	3.0 m	5.0 m	Max.	
6.0 m kg	1 385 1 385			1 210	1 210
5.0 m kg				1 020	1 020
4.0 m kg	1 315 1 315 1 060 1 060			950	950
3.0 m kg	1 710 1 710 1 310 1 225			930	930
2.0 m kg	2 275 2 275 1 275 1 190			950	950
1.0 m kg	2 630 2 400 1 235 1 155			960	950
Ground line kg	2 540 2 315 1 205 1 125			1 050	980
-1.0 m kg	2 105	2 105	2 500 2 275 1 195 1 115	1 150	1 070
-2.0 m kg	3 415	3 415	2 510 2 280	1 370	1 275
-3.0 m kg	2 395 2 340			1 885	1 820

## DIMENSIONS (TRANSPORT)

A Transport length	6 115 mm
B Transport width	2 220 mm
C Upperstructure carriage	2 040 mm
D Height over cabin/ROPS	2 570 mm
E Height of Boom – transport	2 720 mm
F Overall length of crawler	2 820 mm
G Tail length	1 800 mm
H Track gauge	2 195 mm
I Undercarriage width (blade)	2 220 mm
J Horizontal distance to blade	1 735 mm
K Blade height	405 mm
L Track height	680 mm
M Track pads width	450 mm
N Min. ground clearance	380 mm
O Counterweigh clearance	750 mm
P Engine cover height	1 720 mm
Q Tail swing radius	1 800 mm
R Center distance of tumbler	1 750 mm

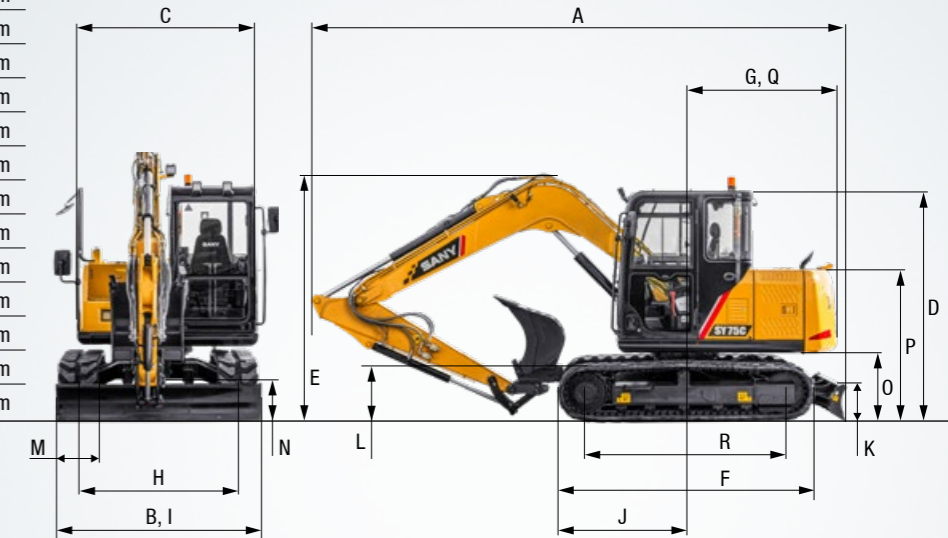

## WORKING AREA

A Max. digging reach	6 505 mm
B Max. digging depth	4 450 mm
C Max. digging height	7 390 mm
D Max. dumping height	5 490 mm
E Min. dumping height	2 040 mm
F Max. vertical digging depth	3 840 mm
G Overall height over arm by min. swing radius	5 560 mm
H Arm head distance with work equipment retracted as far as possible	1 735 mm
I Min. swing radius	1 940 mm
J Max. clearance when blade up	390 mm
K Max. depth of blade down	330 mm

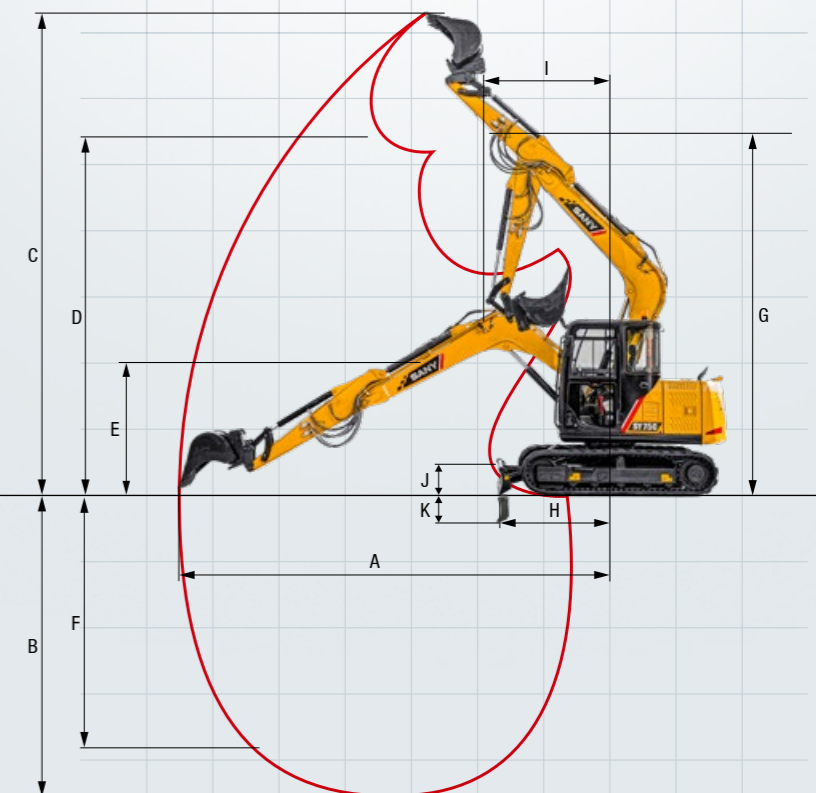

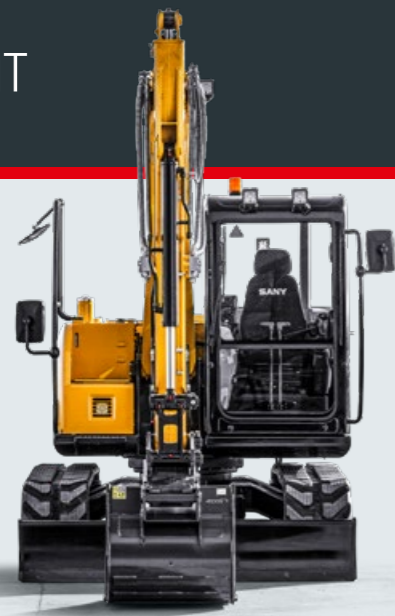

### Always a little bit more

The SANY75C is already fitted with an excellent range of equipment ex-works. Everything is supplied on-board, from the hydraulic quick-hitch already included ex-works as standard, to the extremely robust dozer blade and the Bluetooth interface for using mobile phones.

#### OPERATORS COMFORT / CABINE

Suspension seat	●
Heater	●
Automatic air conditioning C/H*	●
Radio and speaker	●
Armrests (adjustable)	●
USB port (music)	●
Wiper	●
AUX 1 on Joystick	●
AUX 2 on Joystick	●
8 stored hydraulic settings for attachments	●
Bluetooth interface	●

#### SAFETY

Battery master switch	●
Travel Alarm	●
Warning beacon	●
Lockable hoods	●

#### WORKING EQUIPMENT

Boom and arm load holding valves with overload indicator	●
Double acting circuit for hydraulic quick coupler with piping	●
Breaker&Shear line proportional on Joystick with piping	●
Rotation line proportional on Joystick with piping	●
Flow adjustment for attachments	●
Dozer blade	●

Standard equipment ● Special option ●

The standard and special options differ depending on the country in which the crawler excavator is delivered. If you have any questions, please contact your dealer directly.  
\* The air conditioner contains fluorinated greenhouse gases: Refrigerant type: HFC-134a, Global warming potential: 1 430, Quantity: 0,85 kg, CO<sub>2</sub>e: 1,22 t

#### WORKING LIGHTS

Lights – front (LED)	●
Lights – boom (LED)	●
Lights – platform (LED)	●

#### UNDERCARRIAGE

Rubber tracks	●
Steel tracks	●
Holes/loops for fixing	●

#### ENGINE

Auto idle	●
DPF	●
DOC	●

#### HYDRAULIC SYSTEM

Swing brake	●
2 speed travel	●
Piping for additional hydraulic function AUX 1	●
Piping for additional hydraulic function AUX 2	●
Hydr. Pre-pressure operating joysticks	●

# A SERVICE YOU CAN RELY ON

Just as we do with our excavators, we also demand high quality and reliability of our service products. This underlines our equipment's performance in terms of their durability and their excellent price-performance ratio. After all, maintenance is crucial

for efficiency, cost-effectiveness and safety. Your SANY dealer is happy to help you with a comprehensive range of services to ensure that your machine continues operating efficiently in the long term.

### SANY – flexible, fast and always there for you

Rapid assistance, tailored advice and a reliable supply of original parts – that is what we mean by a premium service.

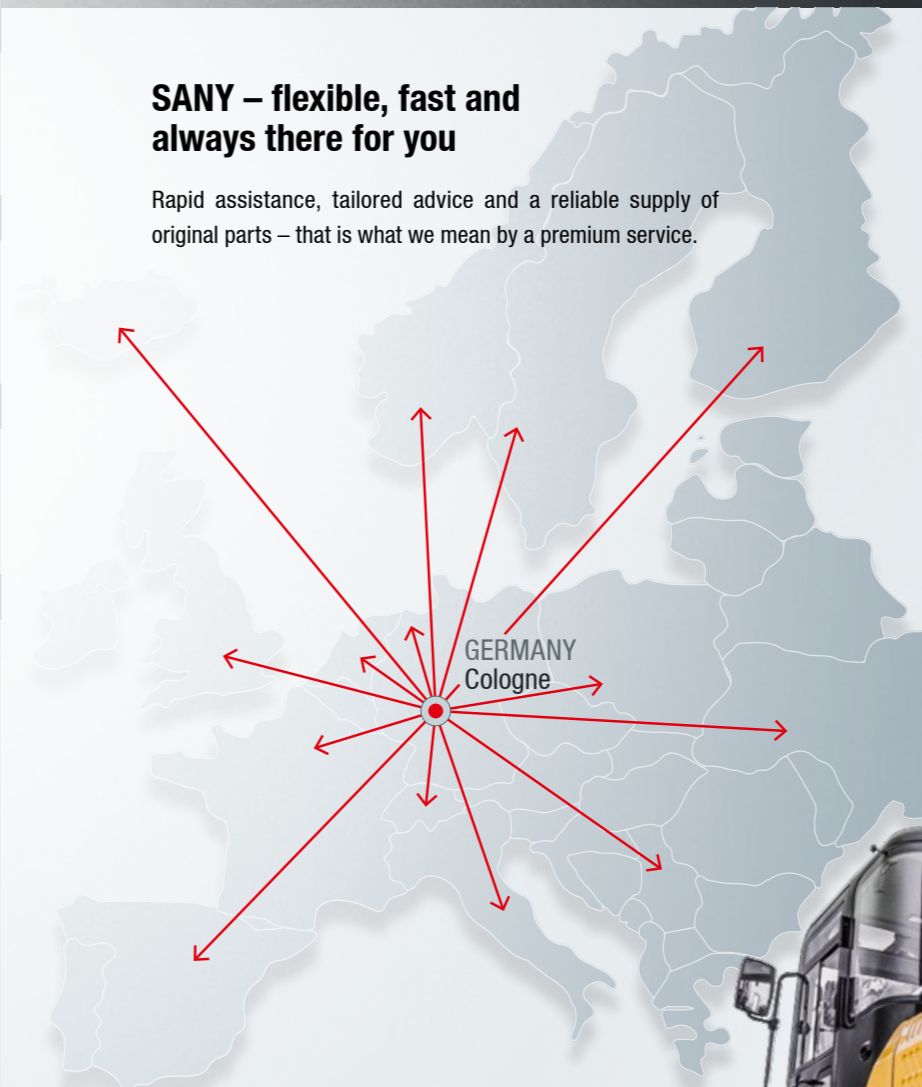

#### The added benefits SANY offers you:

- ✦ Fast supply thanks to the central warehouse near Cologne
- ✦ More than 15,000 spare parts to make your machine highly reliable
- ✦ Expert knowledge for optimal supply for your machine
- ✦ Thanks to SANY's special training programme, our dealers are always kept up-to-date so that they can face all technical challenges.

### Parts supply – quick and reliable

With the purchase of a SANY compact excavator you have made an investment in the future. Fast availability of spare parts is your guarantee of minimal downtimes and failure times.



### Detailed information in black and white

Handbooks and documents are available for all SANY compact excavators, and these can help you with operation, maintenance, servicing and repairs. These include operating and maintenance instructions and technical specifications.



HIGHLIGHTS **SY75C**

# COMFORT MEETS EFFICIENCY

The SY75C is one of the most powerful SANY compact excavators and impresses with its robustness and power. The machine can deliver its full performance, whether in road construction or for loading work. With its powerful drive and compact dimensions, this excavator ensures high productivity during everyday work.



## COMPLETELY COMFORT- ABLE AND SEALED

The driver's cab impresses with its **ergonomically designed controls**, comfortable driver's seat and outstanding visibility on all sides. It is also optimally sealed off and keeps noise, dust and vibrations away from the driver. In addition, the Bluetooth interface makes it easy for the operator to connect their mobile phone in order to answer calls or play music.

## OPTIMAL DESIGN

With the SY75C, you can get a lot done. And it will remain **robust** and work **powerfully**.

## EVERYTHING IN SIGHT

**Perfect visibility on all sides and a rear camera image** on a high-resolution display, offering the best views for precise and safe work.

## POWERFUL AND CLEAN

With its **tailored exhaust treatment**, the Yanmar engine achieves **emission standard Stage V** without any difficulty. This means that it is not only environmentally friendly, but also **fuel-efficient**.

## ALWAYS OPTIMALLY CONFIGURED

The **sensitive joystick** and clearly arranged **controls** allow machine operators to work safely, confidently and with **minimal force**.

## DESIGNED FOR MAXIMUM EFFICIENCY

The intelligent **load-sensing hydraulic system** always knows precisely how much hydraulic power is required for each task and delivers precisely the amount of oil needed.

## TECHNICAL HIGHLIGHTS

Engine	YANMAR 4TNV98CT
Rated power	42.4 kW / 1 900 rpm
Max. torque	241 Nm / 1 300 rpm
Bucket digging force ISO	53 kN
Swingspeed	10.5 rpm
Mainpump	Variable-piston-pump
Max. oilflow	158 l/min



**„FOR OUR COMPANY  
THE PERFECT SOLUTION!“**

Jens Hansen – EGW Eilderts GmbH

Not all products are available in all markets. As part of our continuous improvement process, we reserve the right to modify specifications and designs without giving prior notice. The figures may contain additional options.

# SANY

Quality Changes the World

## SANY EUROPE GmbH

Sany Allee 1  
D-50181 Bedburg  
fon +49 2272 90531 100  
fax +49 2272 90531 109  
info@sanyeurope.com  
www.sanyeurope.com